



SPACE CREATOR VEHICLE PARTITION

FEATURING BDRH (BIDIRECTIONAL RECESSED HOUSING)

(U.S. Patent No. 8,690,216)

2023+ CHEVROLET SILVERADO SSV

Installation Instructions

Space Creator with High Security/High Visibility Window - 475-1987

Space Creator with Full Window w/ Safety Wire Window - 475-2007

Transfer Kit - 475-2002



475-1987

Space Creator Vehicle Partition with HS/HV Window
Featuring Bidirectional Recessed Housing



475-2007

Space Creator Vehicle Partition with Full Window Safety Wire
Featuring Bidirectional Recessed Housing

Before beginning the installation, confirm that you have received all of the parts for your package.

Read the instructions completely before starting installation.

Always install Cargo Barrier before Partition if ordered.

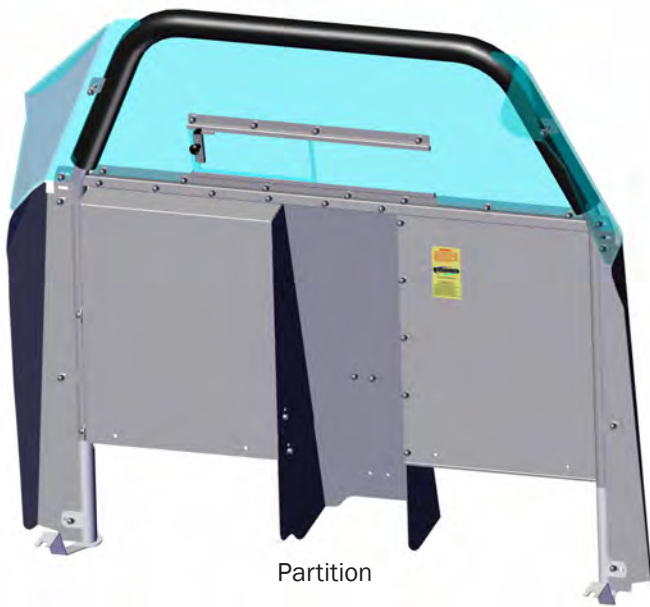

Partition



Partition

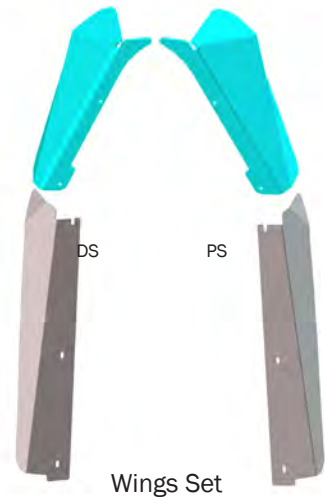

Wings Set



(2) B Pillar Bracket Cover

(2) B Pillar Bracket



Center HSEP



(2) Mounting Foot



BDRH: Bidirectional Recessed Housing

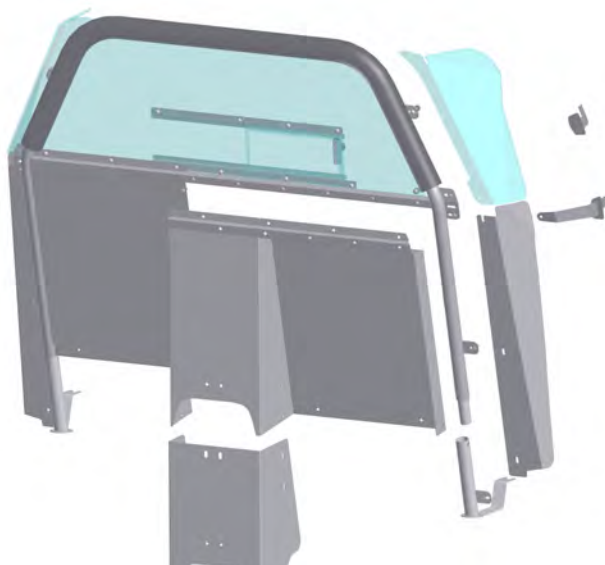

HSEP: High Security Extension Panel
optional

Install Cargo Barrier (CB4) BEFORE Installing Partition



1. Move seats completely forward and loosen the rear outside (T-50 Bolts).



2. Push the seat up slightly to slide the Mounting Foot under seat rail, between rail and vinyl / carpet. Leave bolt loose on this step. Repeat on other side.

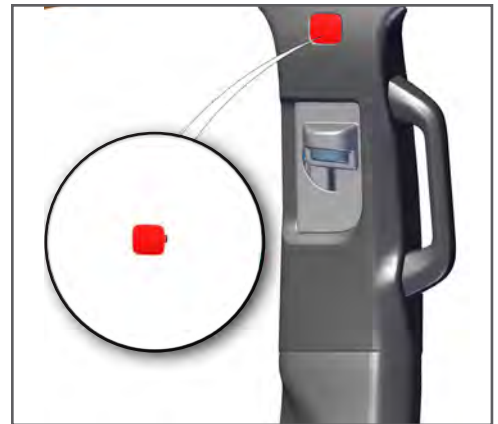

3. Remove the upper B-Pillar trim by popping out the square trim cover, giving access to the screw at the top of the headliner. Then remove with 7mm socket. With slight pressure, pull to unclip the DS/PS Upper "B Pillar trim" from its location

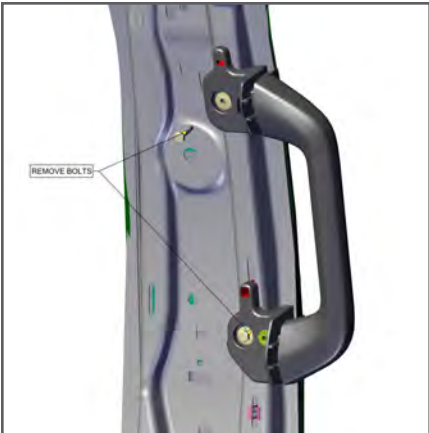

4. Utilize a 10 mm socket to remove the DS/PS Grab Handle.

Grab Handle Not Reused

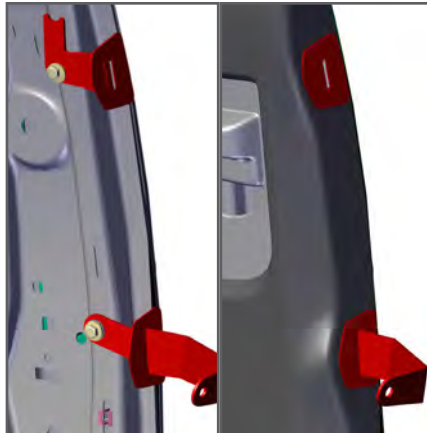

5. Attach the DS/PS B-Pillar Cover Bracket and B-Pillar Bracket with previously removed 10 mm bolts. Replace upper B-Pillar trim and previously removed screw.



6. Install Partition frame into vehicle through DS door and position onto mounting feet.



7. Lean Partition frame forward and loosely attach DS/PS B-Pillar Brackets to middle hole of frame. Center the partition. Once centered, tighten all hardware.



8. Loosely attach Center HSEP onto BDRH outside of vehicle with provided carriage bolts and flange nuts.

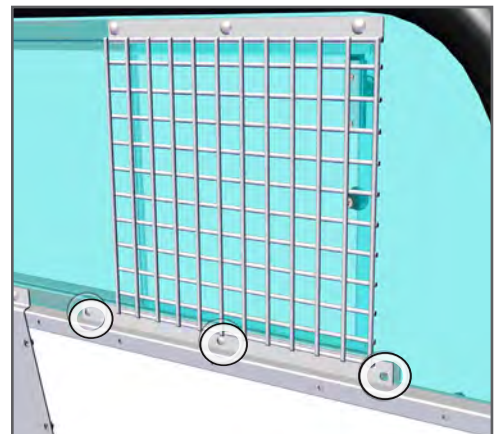

STEP 9-11 (FOR FULL WINDOW ASSEMBLY ONLY)

9. Before you install the BDRH you will need to remove the lower window channel and sliding window by removing the hand tightened carriage bolts and nuts. Remove and set aside for reuse.

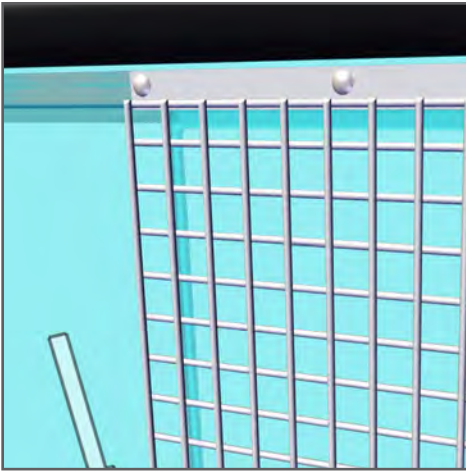

10. When installing the BDRH, be certain the Safety-Wire is installed on the outside of the housing. It will be necessary to pull the bottom of the Safety-Wire out so the UDRH can slip underneath.

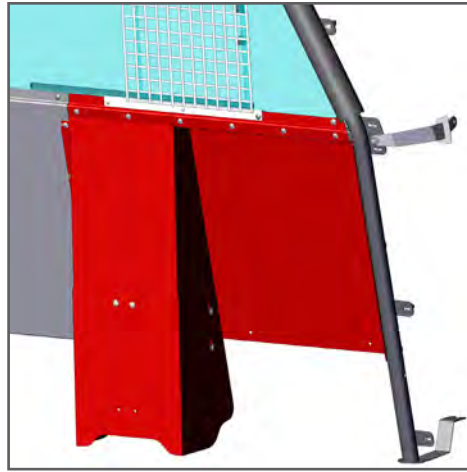

11. Install the assembled BDRH with HSEP to the Partition Frame with previously removed and supplied carriage bolts and flange nuts. Tighten all bolts/nuts.



STEP 12 (FOR HS/HV WINDOW ASSEMBLY ONLY)

12. Place assembled BDRH with Center HSEP into vehicle. Attach the housing To Partition Frame using provided carriage bolts and flange nuts. Push Carriage bolts in from prisoner side of partition. Tighten all bolts/nuts.

SOLO INSTALL NOTE: Use making tape over carriage bolts to hold in place while attaching flange nuts from front side of partition.

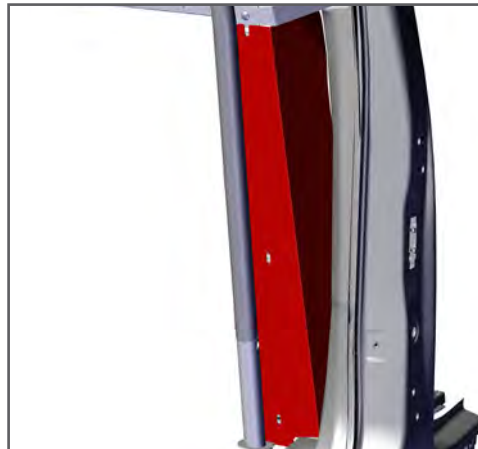
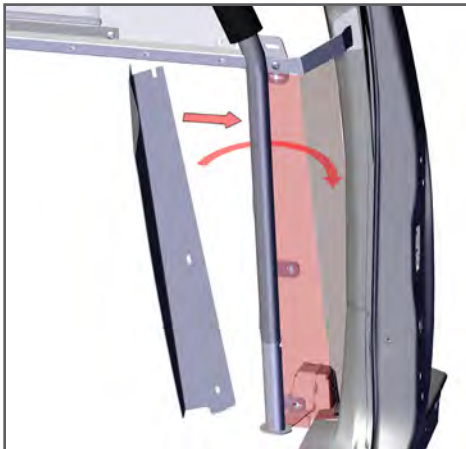

13. Attach the DS/PS Lower Steel Wings through the front of the Partition backwards rotating them 90 degrees around the front side of the tube and mounting tabs of the Partition. Secure with provided carriage bolts and flange nuts.

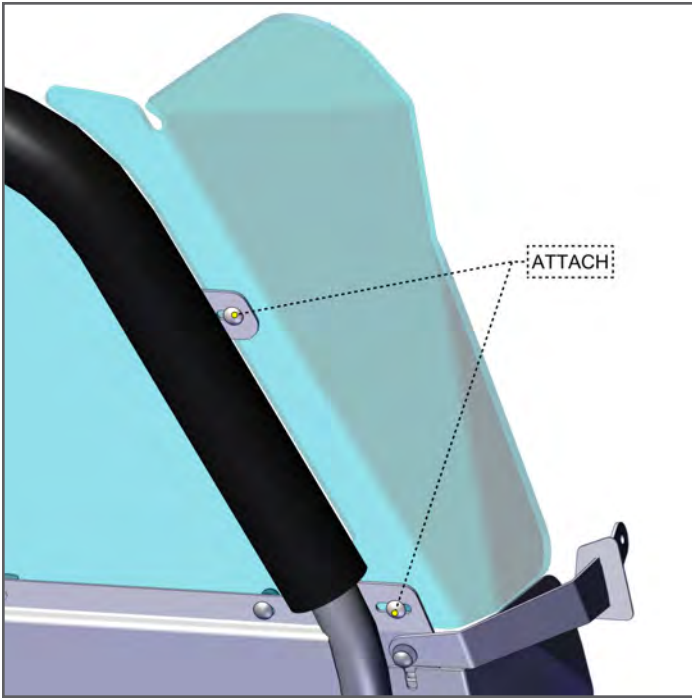

14. Install Upper Poly Wing from officer side and secure with provided carriage bolts and flange nuts. Install cap nut covers on all flange nuts.

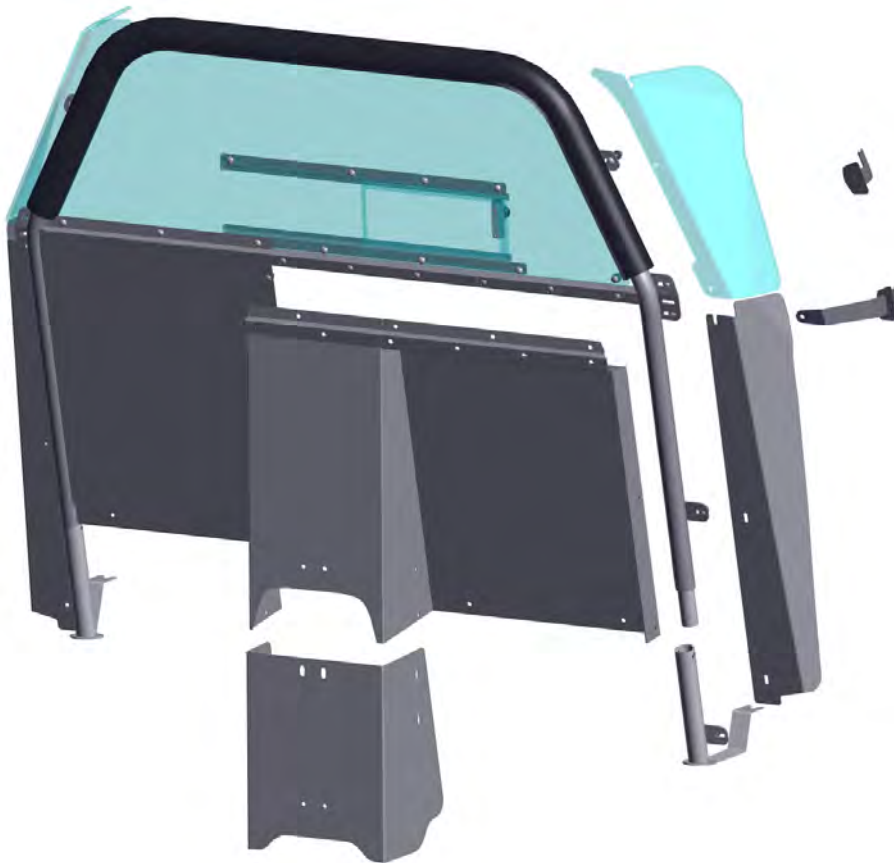

If you have questions or need further assistance please call Technical Support: 1.877.455.6886



209 W. EASY ST., ROGERS, AR 72756 • JOTTOPUBLICSAFETY.COM • 9/24

Jotto Desk™ is a patented product and Registered Trademark of Assembled Products™ Corporation.
Specifications subject to change without notice.

050-0079-00



ASSEMBLED